

Wireless Ultrasonic Level Sensor (HWM-5M/10M)

USER'S MANUAL

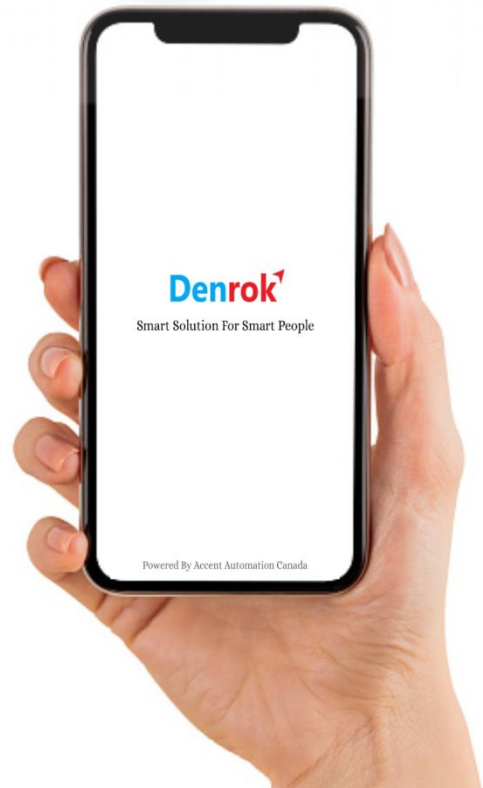

Google Sheets

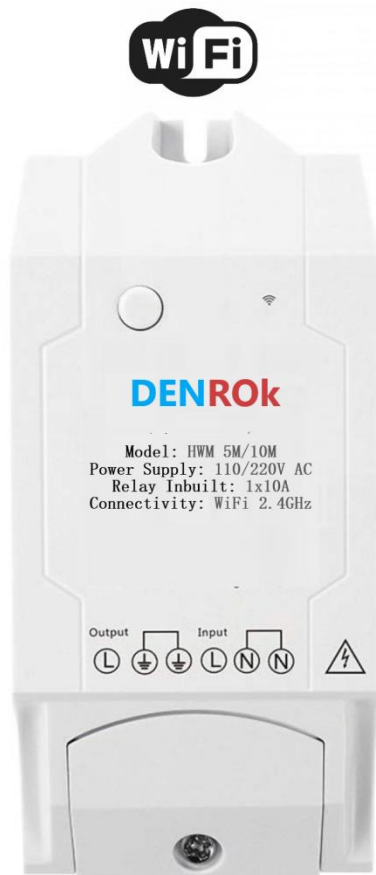

WiFi Supported



History Recording



Push Notifications



Remote Control

Get started

You can download the Accent-Smart Industry app by searching for Accent Smart in your app store or by scanning the following QR code.



Registration, login, and password reset

1. **Open the Accent Smart app and tap** Sign Up and Fill all required information's then **tab** Signup.
2. **Enter Username and Password and tap** Login. **In the** User Agreement and Privacy Policy **dialog box, carefully read the privacy policy and agreement and tap** Agree **to go to the Main home page.**

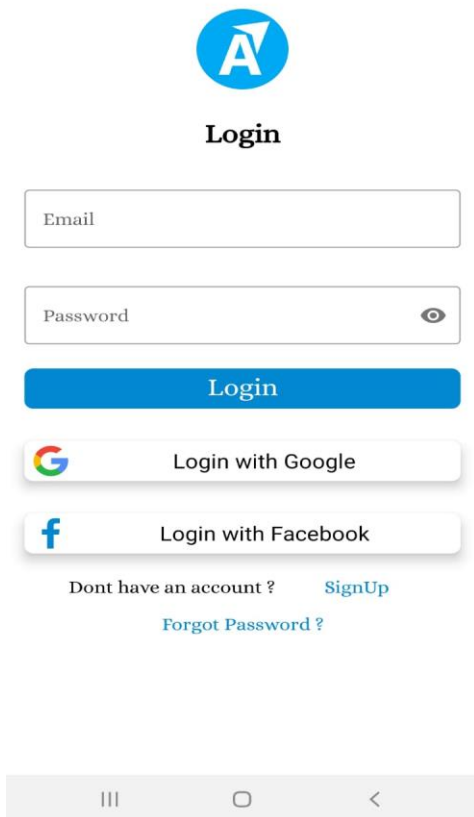
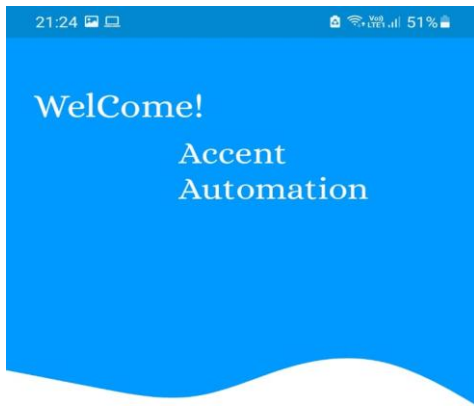

3.

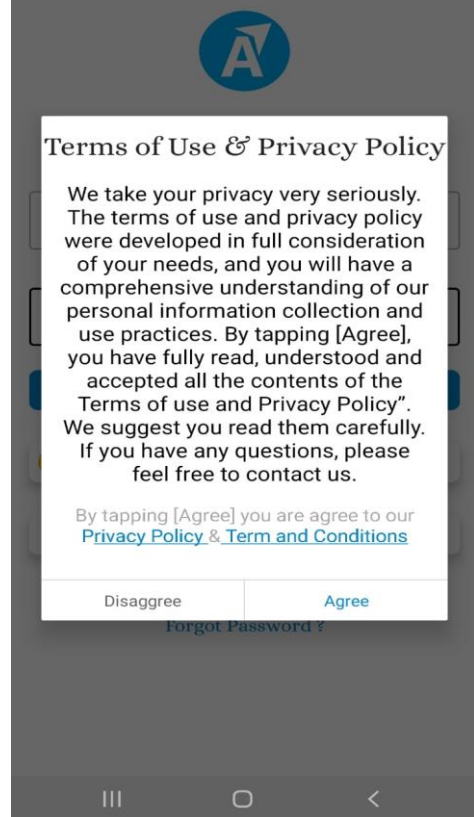
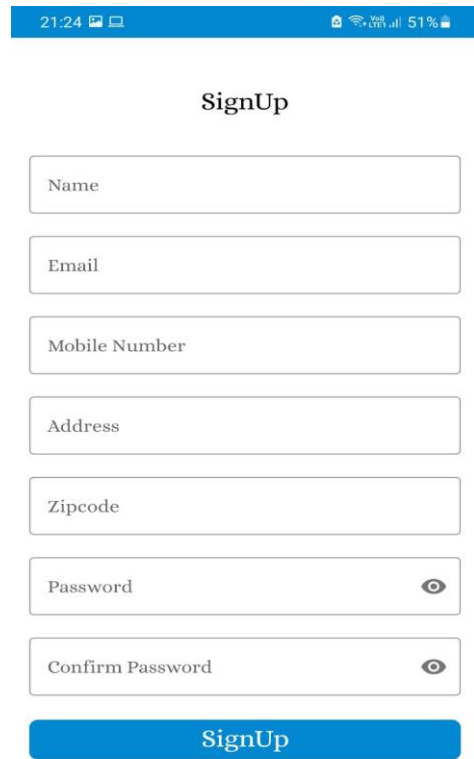

Forgot password

If you forget your login password, you can reset the password based on the following process:

1. On the Log In page, tap **Forgot** Password.
2. Enter your email address and tap **Submit**.
3. Check your **Email** Inbox/Spam for **New Password**.
4. Enter Email ID and New Password and **tab** Login.

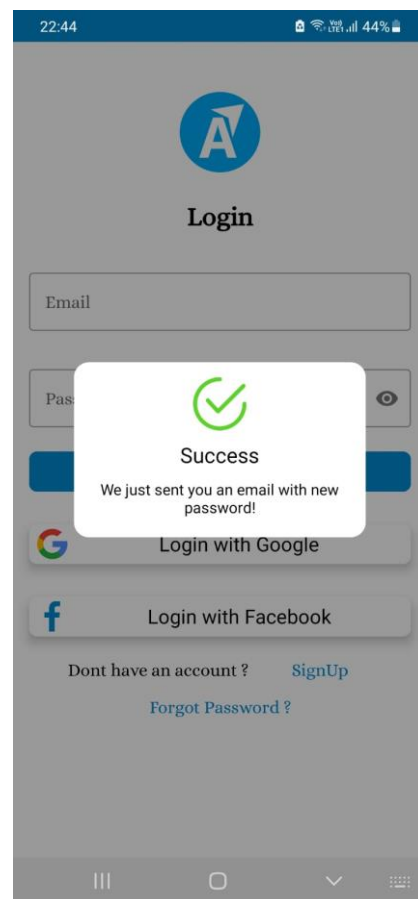
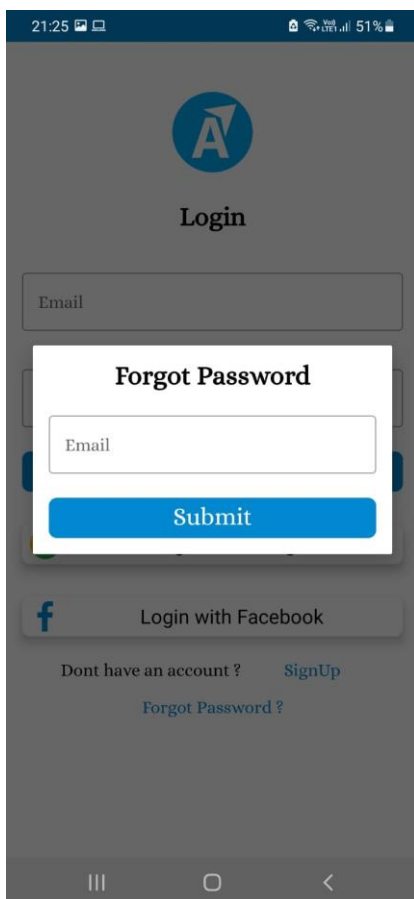

Change password

If you want to change the password, you can change the password based on the following process:

5. On the Home page, tap **Profile** and then **tab** on **Reset Password**.
6. Enter your old password and new password and tap **Submit**.
7. Enter Email ID and New Password and **tab** Login.

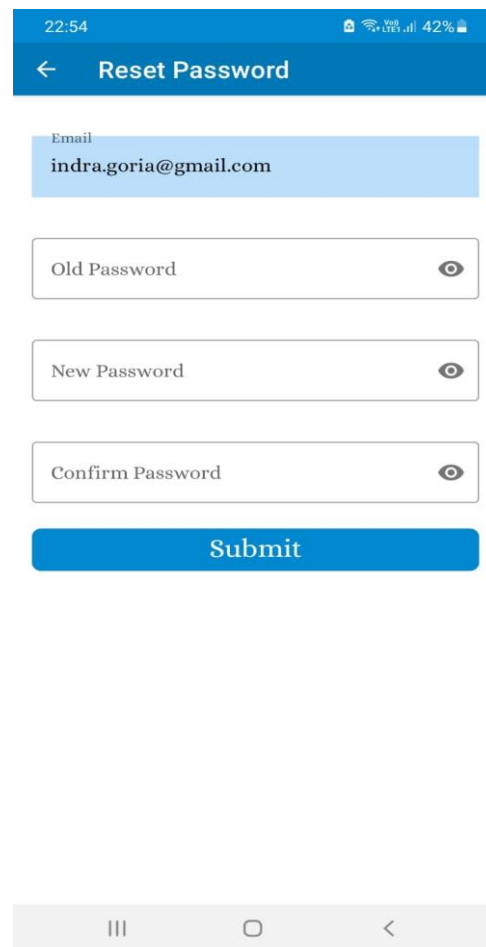
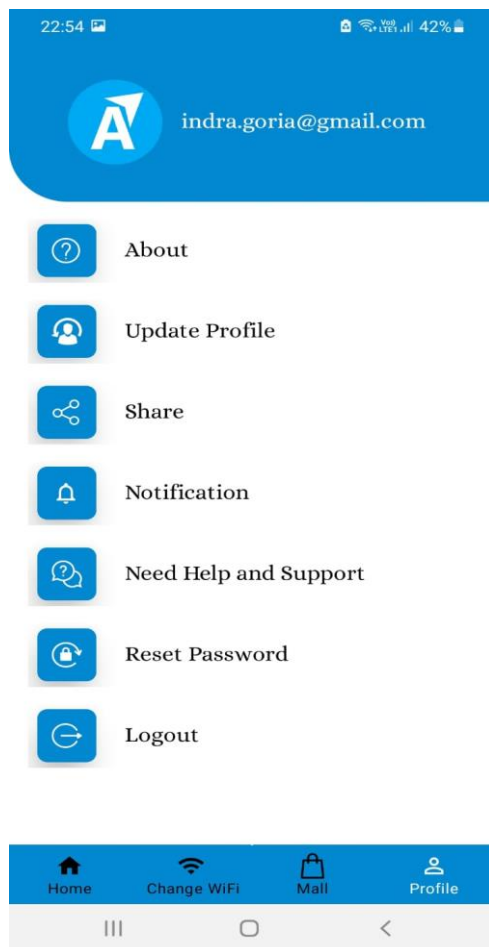

Wiring instruction

WARNING: Connect Power Supply very carefully.

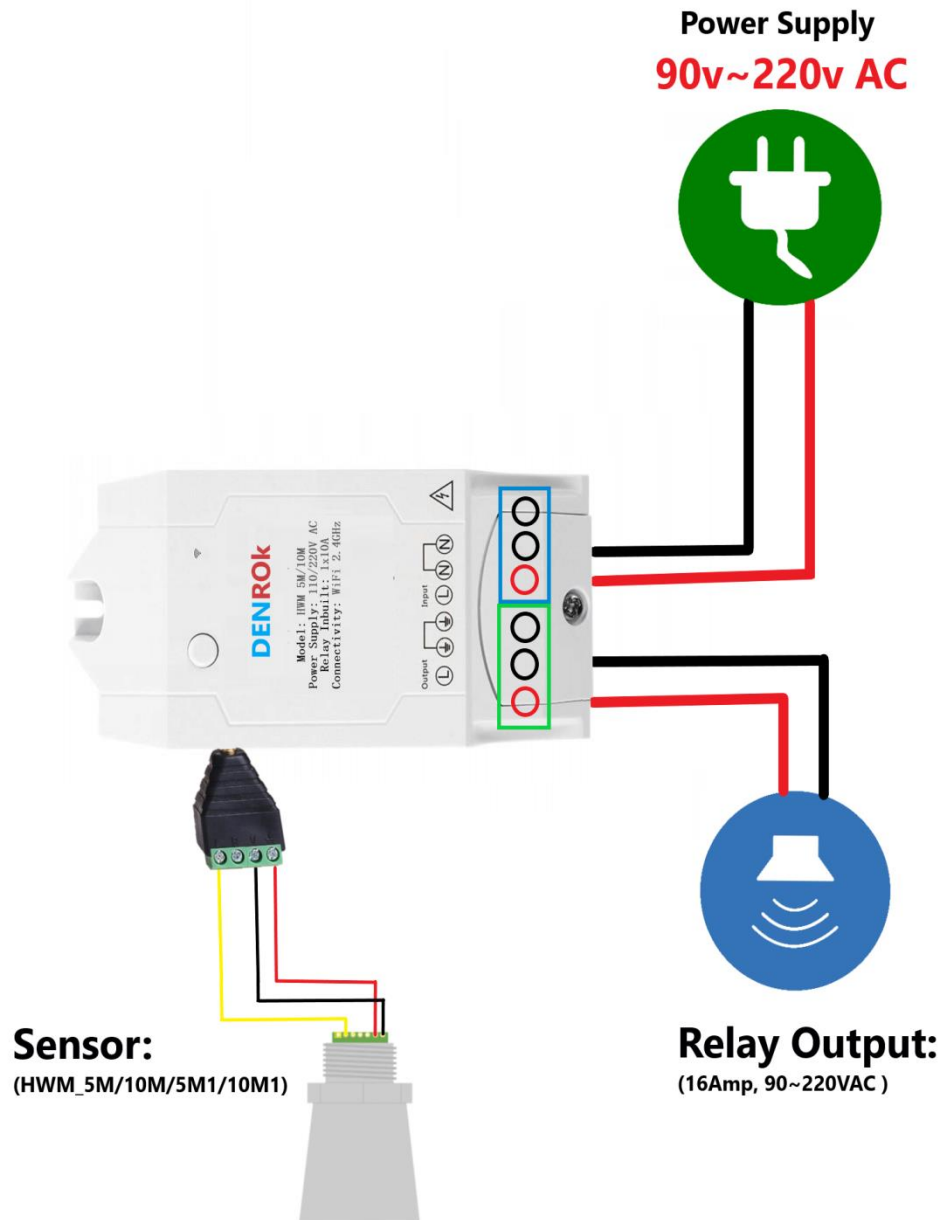

Sensor Installation Guide

Sensor alignment

The sensor face has to be parallel to the surface
Of the liquid within $\pm 2-3^\circ$.

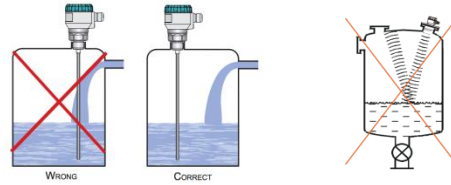

Temperature

Make sure that the Ultrasonic Level Transmitter
Will be protected against overheating by direct sunshine.

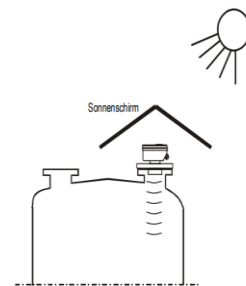

Quick Setup Using Accent Android app

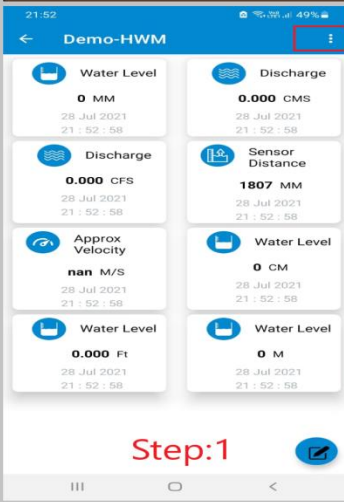
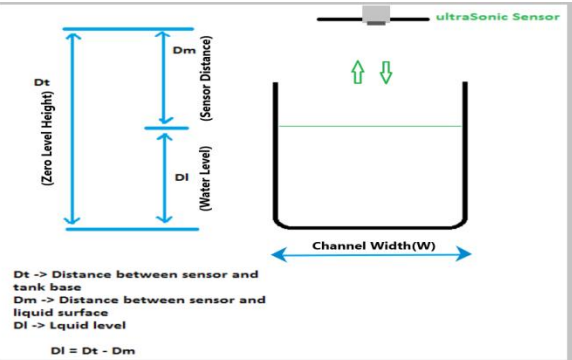
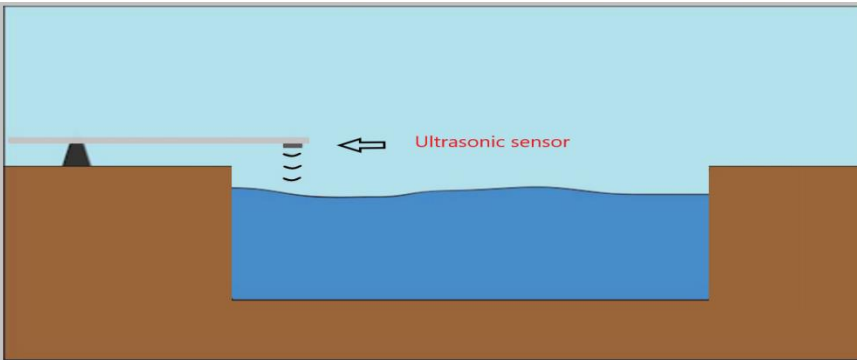

Step: 1

On realtime page, Click on three dot icon

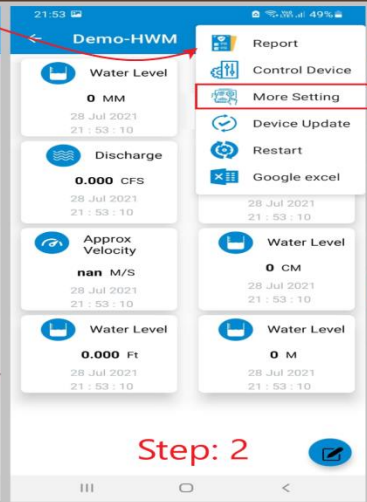

Step: 2

Tab on more setting option

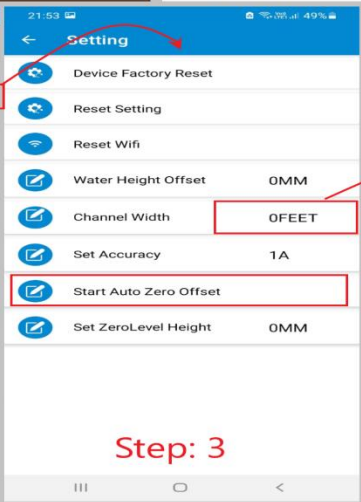

Step: 3

Enter Channel Width in Feet

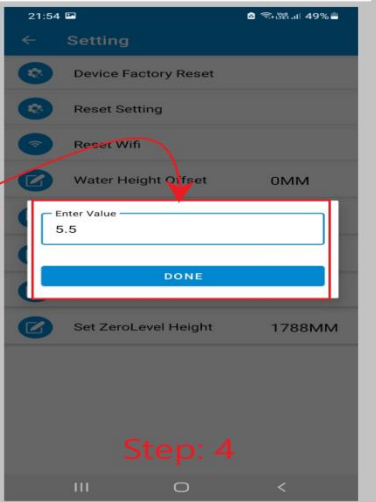

Step: 4

Tab on Done

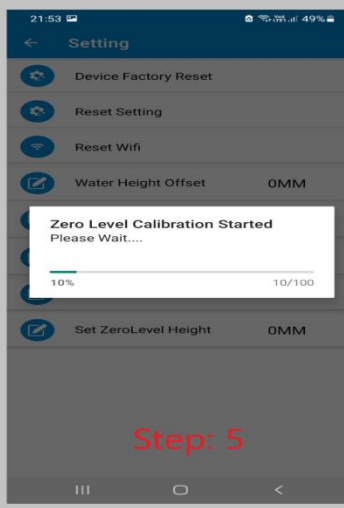

Step: 5

Tab on Auto Zero Level Offset (Channel should be empty)

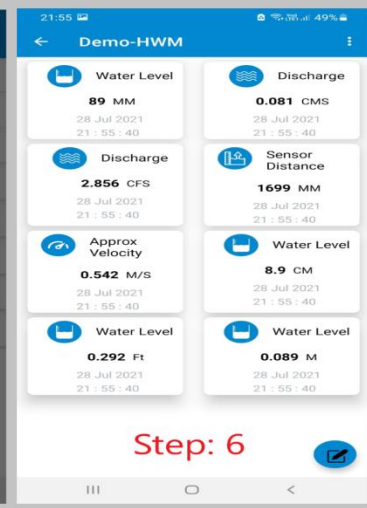

Step: 6

Now start measurement Finish!!!!!!

Programming or Setting using Accent Android App.

- 1. Sensor Mounting**
- 2. Sensor Power**
- 3. Sensor WiFi connections (Refer Page No.)**
- 4. Set Zero level: Manual vs Auto**
- 5. Set Channel Width**
- 6. Set Accuracy level: Make table for this**
- 7. Configure wifi**

Miscellaneous:

- 1. Set water level offset**
- 2.**